



# User Manual



**WARNINGS:** Read carefully the instructions included in this Manual before using the Device.

Emoled srl

Registered office:  
Via de' Bardi, 36  
50125 Firenze

Headquarters:  
Via di Rimaggio 141, int 25  
500019 Sesto Fiorentino

[www.emoled.com](http://www.emoled.com)



Document 8300010001\_UM\_rev.5; 14/12/20.

<b><u>1</u></b>	<b><u>INTRODUCTION</u></b>	<b><u>4</u></b>
1.1	RELEVANCE OF THIS MANUAL	4
1.2	MANUAL CONSERVATION	4
1.3	WARNINGS	4
1.4	SYMBOLS	6
<b><u>2</u></b>	<b><u>GENERAL INFORMATION</u></b>	<b><u>7</u></b>
2.1	INDICATION OF USE	7
2.2	ACTION MECHANISM	7
2.3	EXPECTED PERFORMANCES	7
<b><u>3</u></b>	<b><u>PRODUCT DESCRIPTION</u></b>	<b><u>8</u></b>
3.1	DESCRIPTION OF THE DEVICE AND ACCESSORIES	8
3.2	GENERAL	8
3.3	OPERATING INSTRUCTIONS	9
<b><u>4</u></b>	<b><u>DEVICE USE</u></b>	<b><u>11</u></b>
4.1	DEVICE REGISTRATION AND DAY AND TIME SETTING	11
4.2	SERVICE AREA	11
4.2.1	TREATMENTS RECHARGE	12
4.2.2	COUNTERS	12
4.3	THERAPEUTIC USE OF THE DEVICE	12
4.4	DISTANCE SENSOR	14
4.5	OPERATIONS TO BE ACCOMPLISHED AFTER DEVICE'S USE	14
<b><u>5</u></b>	<b><u>LABELS</u></b>	<b><u>15</u></b>
<b><u>6</u></b>	<b><u>WARNINGS/ERROR MESSAGES/MALFUNCTIONS</u></b>	<b><u>16</u></b>
<b><u>7</u></b>	<b><u>DEVICE MANAGEMENT</u></b>	<b><u>17</u></b>
7.1	CORRECT USE	17
7.2	DEVICE CONSERVATION	17
7.3	PACKAGING AND SHIPPING	17
7.4	DISPOSAL	17
7.5	CYBERSECURITY	17
<b><u>8</u></b>	<b><u>TECHNICAL DATASHEET</u></b>	<b><u>18</u></b>
<b><u>9</u></b>	<b><u>ELECTROMAGNETIC COMPATIBILITY</u></b>	<b><u>19</u></b>
<b><u>10</u></b>	<b><u>GLOSSARY</u></b>	<b><u>23</u></b>
<b><u>11</u></b>	<b><u>GUARANTEE</u></b>	<b><u>24</u></b>
	<b><u>MANUFACTURER COMMUNICATION FORM</u></b>	<b><u>25</u></b>
<b><u>12</u></b>		<b><u>25</u></b>

# 1 INTRODUCTION

## 1.1 Relevance of this Manual

The present MANUAL is the user's guide for the medical device named EmoLED employed as an **adjuvant** to the healing of wounds in its version 1 including its embedded software called SanaLight, version 2.1.

In the present document "EmoLED" or "Device" will be referring to the medical device EmoLED used as an adjuvant for the healing of wounds.

The Device is made of two parts: the upper part, from where the **luminous radiation** is coming from, it is defined as "Head" of the Device or "Optical Head" and the lower handling part identified as Device's "Body". The correct performances and duration in time of the Device are depending on its correct use and the respect of the following instructions.

This Manual is an integral part of the Device and must be kept for the entire useful life of the Device according to its definition here after.

It is recommended the careful reading of the Manual before using the Device.

## 1.2 Manual conservation

Use the manual doing attention to not damage its content.

Do not remove, cut or modify any part of the Manual for any reason.

Keep the Manual in an environment protected from humidity and heat.

This document is exclusive property of EMOLED Srl. It is forbidden any copy or reproduction, even partial, of its contents.

## 1.3 Warnings



**ATTENTION: THE INAPPROPRIATE USE OR NEGLIGENCE IN THE MAINTENANCE OF THIS DEVICE MAY RESULT IN INJURIES TO THE USER, TO THE PATIENT AND TO THIRD PARTIES. TO AVOID ANY RISK, IT IS RECOMMENDED TO FOLLOW CAREFULLY THE INSTRUCTIONS HERE CONTAINED.**



**DANGER: DEVICE EMITTES UV RAYS**

The Device has LED sources in Risk Class III. Do not aim directly to the eyes and avoid skin exposure outside the medical treatment. It is suggested for people present in patient's area to use glasses with UV protection.



**ATTENTION: EMISSION OF POTENTIALLY HARMFUL OPTICAL RADIATION**

Do not look directly into the emitted light. Blue light may be harmful to the eyes.



**IN CASE OF NON UNIFORM LIGHT EMISSION**

Do not use the Device and contact assistance: [www.myemoled.com/contacti](http://www.myemoled.com/contacti).



**DO NOT USE UNAUTHORIZED PERSONNEL FOR MAINTENANCE**

For any type of intervention or problem contact the Manufacturer: [www.myemoled.com/contacts](http://www.myemoled.com/contacts).



**DO NOT USE DEVICE BEFORE DISINFECTION**

Before use disinfect the Device with sterilized gauze soaked with ethylic alcohol at >50%. DO NOT INSERT THE DEVICE IN AUTOCLAVE AND DO NOT USE DISINFECTION METHODS DIFFERENT FROM THESE HERE SPECIFICATED.



**DO NOT INTRODUCE FOREIGN BODIES IN THE USB PORT AND IN THE POWER JACK. DO NOT CARRY OUT UNAUTHORIZED CONNECTION**

Battery could be recharged only in clinical/hospital environment using the charger that is supplied together with the Device.



**KEEP THE DEVICE DRY**

Don't use it with wet or sweaty hands.



**DO NOT GIVE THE DEVICE TO PEOPLE ANAWARE OF THE RISKS OR NOT AUTHORIZED TO USE**

This Device can be used only by professional healthcare staff, namely physicians or nurses. Read carefully the Manual before use.



**IN CASE OF DAMAGE OF THE PLASTIC EXTERNAL ENCLOSURE**

It is absolutely forbidden to start disinfection procedures in case of loss of integrity of the Device exterior plastic enclosure to avoid liquid ingress. Place device in its case, if possible, and contact assistance: [www.myemoled.com/contacts](http://www.myemoled.com/contacts).



**IN CASE OF TOUCH SCREEN DAMAGE OR NOT WORKING**

**Do not use the Device.** Proceed with a maintenance intervention request: [www.myemoled.com/contacts](http://www.myemoled.com/contacts).



**PROTECT DEVICE FROM SUNLIGHT**



**DO NOT USE IN CASE OF NEOPLASTIC WOUNDS**



**DO NOT USE ON PATIENTS WITH PORPHYRIA**



**CASE OF COMPLETE ROTATION OF THE OPTICAL HEAD**

Do not use, contact assistance: [www.myemoled.com/contacts](http://www.myemoled.com/contacts).



**DO NOT COVER THE DISTANCE SENSOR**

In case of occlusion of the distance sensor the Device will not start the treatment.



**DO NOT COVER THE AREA EMITTING LIGHT**



**ATTENTION**

It is not possible to switch on the Device when it is connected to the main power. In order to use the Device it is necessary to disconnect it from the electrical line.

**Do not recharge** the device outside clinical/hospital environment.



**DISINFECTION GUIDE**









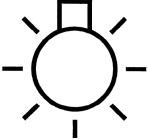

**DO NOT REPROCESS. DO NOT SUBMERGE**

Disinfect with surface disinfectant wipes prior to use. ie Clinell or Tuffy wipes

There are no restrictions regarding disinfection agents

ie Ethanol, NaOCl, Chlorhexidine, Benzalkonium Chloride, PHMB, HOCl or combinations.

## 1.4 SYMBOLS

	<p>IEC 60417-5010 symbol: shows the ON/OFF Button. Press the Button to switch ON or OFF the Device.</p>
	<p>IEC 60417-5012 symbol: shows the presence of a light source. Used in combination with ISO 7000-0434A symbol on the Optical Head point out the presence of a risk in connection with the light emission.</p>
	<p>ISO 7010-M002 symbol: shows that it is necessary to read instruction before use.</p>
	<p>ISO 7000-0434A symbol: shows that it is necessary to read instruction for relevant safety information that can not be reported directly on the Device for different reasons.</p>
	<p>ISO 7000-2498 symbol: followed by an alphanumeric code, identifies the Device Serial Number.</p>
	<p>ISO 7000-2497 symbol: shows the date of manufacturing of the Device.</p>
	<p>ISO 7000-3082 symbol: identify the manufacturer of the Device, according to EU directives 90/385/EEC 93/42/EEC and 98/79/EC.</p>
	<p>ISO 7000-0621 symbol: shows that the Device can be damaged if not handled with care.</p>
	<p>ISO 7000-0626 symbol: shows that the Device must be protected from moisture.</p>
	<p>Upper side. This symbol on the delivery box indicates the upper side of the box itself.</p>
<p><b>FRAGILE</b> PLEASE, HANDLE WITH CARE</p>	<p>Fragile. This symbol on the delivery box indicate the Device must be handled with care.</p>
	<p>RAEE symbol. The Device must be disposed according to the standard CEI EN 50625-1:2015 regarding electronic and electrical waste.</p>
	<p>Service area. Clicking on the symbol shown in the touch screen is possible to access the service area.</p>

## 2 GENERAL INFORMATION

### 2.1 Indication of use

EmoLED is a Medical Device to be employed as an adjuvant therapy for the healing of acute and chronic wounds of people older than 16 years. It is a portable, contactless and powered by rechargeable ion lithium batteries Device. EmoLED does not requires installation but must be [set for service](#) and it is not intended to be used in combination with other devices.

### 2.2 Action mechanism

EmoLED uses 6 LED light sources emitting Blue Light between 400 and 430 nanometers (nm). The emitted wavelengths coincide with the absorption spectrum of specific blood and skin chromophores as is the [Protoporphyrin IX](#): through the interaction with those chromophores EmoLED activates the physiological healing process in a natural and non-invasive manner.

In the presence of blood as in the case of acute wounds, Blue light acts mainly through the mechanism of selective [photothermolysis](#): by irradiating the Hemoglobin, through a selective and controlled blood temperature rise located at wound level, the process of hemostasis is stimulated, spontaneously activating different physiological phenomena that contribute to healing.

In the event of poor lesion vascularization, as in the case of chronic wounds, the [photochemical effect](#) is prevalent: in this instance a cascade of events is generated by the interaction of the Blue Light with molecules such as Cytochrome C and the Flavins.

Cytochrome C is a hemoprotein found on the mitochondria membrane which interacts with the last two mitochondrial transport chain complexes. Once activated by the Blue Light, this hemoprotein contributes to strengthening the cellular respiratory process, increasing the production of ATP: this results in an increase in the cell's energy which can intensify its metabolic activity, a process necessary during the wound's healing process. Through the activation of the Flavins, the Blue Light stimulates the production of ROS (reactive oxygen species), signal transducers that induce activities to overcome the inflammatory loop and the local angiogenesis. The emitted radiation is made uniform in the whole irradiated area by the Device optical system and reaches a power density of 120 mW/cm<sup>2</sup> if kept at the recommended using distance (see Fig.3).

EmoLED is classified, according the actual regulation, as a IIa class Medical Device.

### 2.3 Expected performances

EmoLED has been conceived and designed to be used in the therapy of acute and chronic wounds by professional healthcare staff. In particular EmoLED treatment is an aid to standard therapy and it is part of the [wound bed preparation](#).

The recommended treatment regime is one application at every wound cleansing and dress changing session. Clinical experience has demonstrated the effectiveness of EmoLED when applied at least once a week to reduce wound healing time, inflammation and pain. The user should be a wound care specialist. The accessible parts of the Device, namely all the enclosure, are made of polycarbonate material, except lens, display and the screen for the visual comfort. All parts can be cleaned following the procedure explained after.

The area interested by EmoLED treatment is the wound bed and the perilesional skin both in case of acute or chronic wounds. There are no particular restrictions about the treatable wound types with the exception of neoplastic wounds and patients with porphyria.

The application time is 60 seconds and it covers a 50 mm diameter circle area. In case of larger wounds, the full treatment will consist in several successive applications on the adjacent zones until the full wound area is covered (see Fig.4). If fully charged an average of 150 applications can be performed without recharging. In case of partial superimposition of the treated areas there are not other risks due to excessive dosage or contraindications.

There are no risks to the use of EmoLED according to the present indications.

Possible side effects: scientific literature reports that blue light use could result in a temporary and transient hyperpigmentation of the perilesional skin. In described cases, hyperpigmentation disappears in a few tens of seconds. Such event has not been directly observed.

**NOTE.** Light emitted by EmoLED could be dangerous for eyes.

### 3 PRODUCT DESCRIPTION

#### 3.1 Description of the Device and accessories

EmoLED is a portable medical device powered with rechargeable batteries, made of two distinguished parts (see Fig. 1 and 2):

- the Optical Head containing the LED sources and the distance sensor;
- the Body containing a touch screen, a Button with the ON/OFF function, a power connector and a micro USB port.

Supplied Accessories are:

- the charger (shown in Fig. 20);
- the screen for visual comfort to be placed on the Optical Head before starting application (see Fig. 6);
- UV filtering glasses.

#### 3.2 General

The Device emits a uniform electromagnetic radiation in the visible range (blue light) over all the irradiated area.

Recommended distance of application is 4 cm from wound bed; but it is acceptable to keep a range of distance between 3 and 5 cm during application. An indicator on the screen help the user to keep the proper distance (see par. 4.3). If the distance is outside the given parameters the application is paused automatically (see par. 4.4). The application time has been defined according to results of preliminary studies and clinical trials.

If the wound is larger than 5 cm follow the procedure: insert the wound dimensions as described in section

FIGURA 1 – Front view with the Optical Head in resting mode



FIGURA 2 – Rear view



FIGURA 3 - Suggested distance for treatment



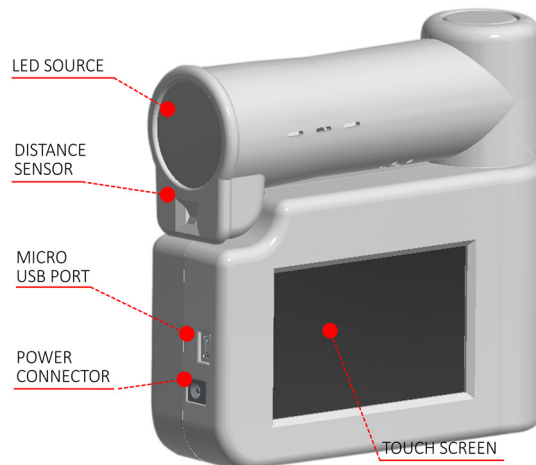

4.3, the Device will automatically calculate the number of applications needed to cover the whole area.

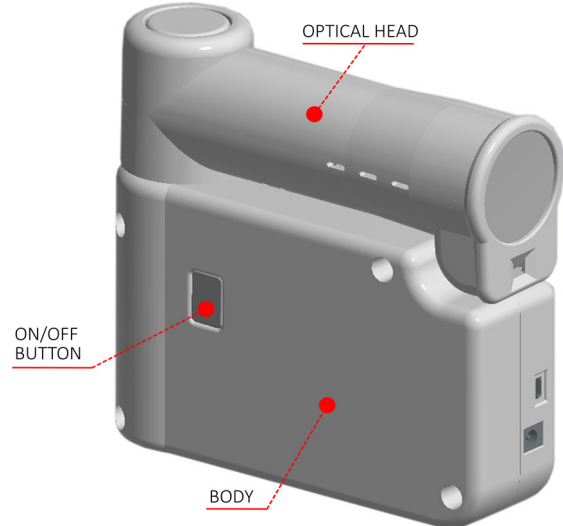
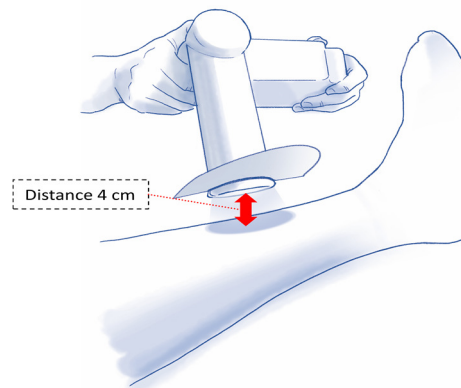
At the end of first application the user must move the Device to the adjacent area and press OK to start the next application, repeating the action until the end of the whole treatment. In order to limit consumption of applications it is recommended to pay attention not to overlap the treated areas.

**NOTE.** The Device will start only if the battery charge is enough to terminate the whole treatment. Otherwise to the display will appear the signal of insufficient charge.

### 3.3 Operating instructions

1. Open the case and extract the Device and the accessory screen for visual comfort.
2. Clean the Device with sterile gauze soaked in ethylic alcohol at 50%.
3. Place the accessory screen on the Optical Head near to the front frame as shown in Fig. 6.
4. Set the Optical Head in the best position for the use pulling slightly the head, rotating and releasing it, as described in the image sequence in Fig. 5.
5. Press the ON/OFF Button (Fig. 2) to switch on the Device.

Figure 4: Example of calculation of the area to treat and multiple applications



FIGURA 5 – Optical Head orientation procedure



The “ready to use” position is with the Optical Head aimed to the lesion and the touch screen always in sight facing the operator (see Fig. 7). It is recommended to use the rotation of the Optical Head to obtain the best positioning possible avoiding rotations of Device’s body. Maximum Optical Head rotation allowed 180°. The complete rotation is prevented by a mechanical stop.

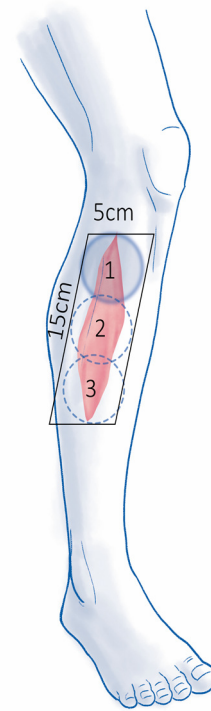
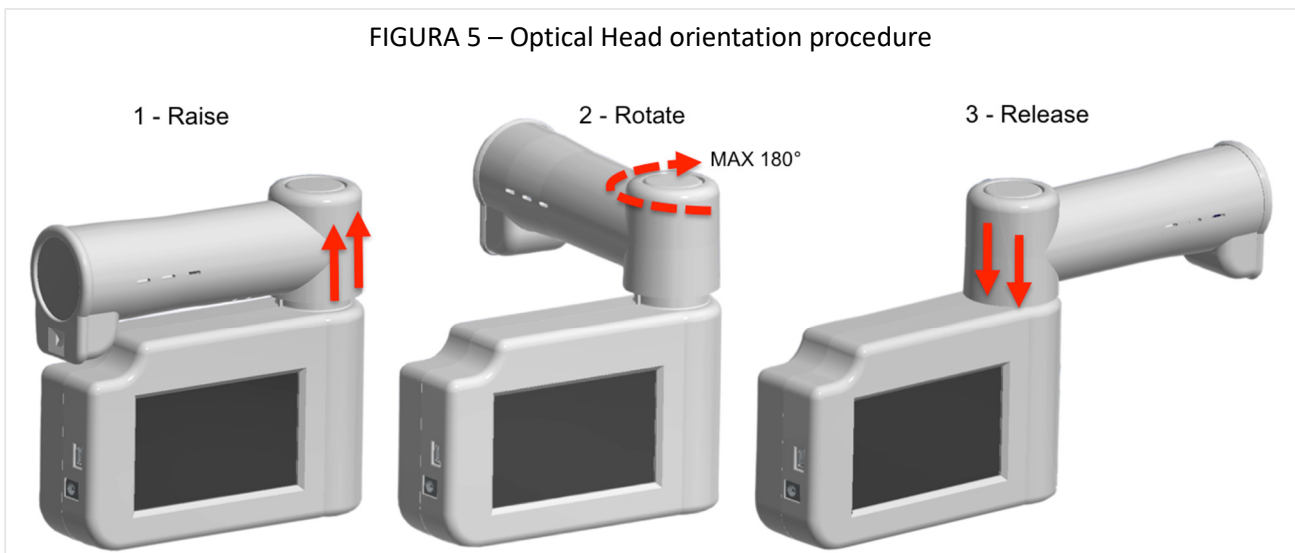

**In case of complete rotation of the Optical Head, contact immediately the assistance**

During the normal use the Device's body is kept parallel to the wound plane with the Optical Head aimed toward the application area.

**NOTE.** Maximum screen inclination 90° forward and 30° backward (see Fig. 8).

The **distance** of the Device's Head from the wound should be 40 mm ( $\pm 10$  mm): a specific indicator helps the operator to keep the proper distance during treatment.



**It is strongly recommended to not use the Device in positions other than the suggested.**

During therapy the Device must be held by sanitary personnel. Patient should not enter in contact with EmoLED and the user should not touch any part other than the touch screen and the plastic parts of the body. All contacts, including fortuitous contacts, occurred by the patient and the sanitary personnel, if not described



**It is strongly recommended to use the screen for visual comfort, to not use the Device on the eyes and not aim at them.**

in the present manual are to be considered as use errors or improper use.

### 3.4 Functions of the ON/OFF Button

The ON/OFF button (see Fig.2) has different functions:

- switch ON the Device by a fast finger pressure;
- switch OFF the Device by a long finger pressure: on the screen appears the following message: "RELEASE BUTTON AND PRESS OK.
- reset the Device by an even longer finger pressure.

**NOTE.** If not used for ten minutes the Device turns off.

FIGURE 6 – Placement of the screen for visual comfort

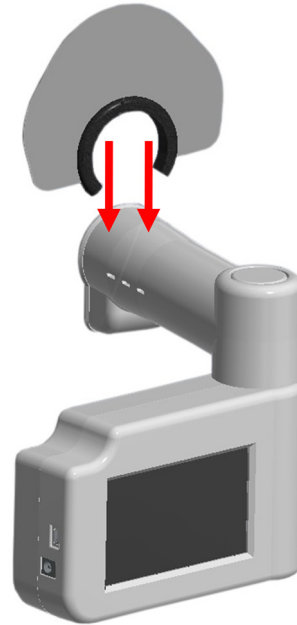

FIGURE 7 – Position of correct use



## 4 DEVICE USE

### 4.1 Device registration and day and time setting

Here below are described the steps to be taken for the first starting of the Device and its registration followed by the action to be taken to start a treatment.

1. Select language by pressing on the corresponding flag button (see Fig.9).
2. Automatically it opens up the area for the registration of the user of the Device. Insert the required information using the alpha-numeric keyboard and press "OK" (see Fig.10).

**NOTE.** It is necessary to fill out all fields otherwise an "ERROR" message will appear..

**Status Barr:** always present in the upper part of the screen (see Fig. 11).

3. Automatically the screen to set date and time opens up. (see Fig. 12). In the same screen appears the Device's preset identifying serial number that is also visible on the label placed at the bottom of the body (see section 5). Go on pressing "OK".
4. Disclaimer: automatically on the display appears a text summarizing use conditions of the device, including responsibilities connected to improper use. Press "READ AND ACCEPT" to accept and go forward.
5. Automatically appears the treatment recharge screen (Fig.13). Insert the recharge code that is supplied separately and press the "RECHARGE" botton.

If the procedure has been correctly executed on the display appears the Home screen (see Fig. 15) and in the status bar the right counter shows the number of available treatments.

### 4.2 Service Area

From "Home"

screen it is possible to access the Service Area (Fig.14) by pressing the access button to the Service Area placed in the status bar (Fig.11). In here are located the internet address for the help service and buttons for

FIGURE 8 – Max inclination allowed

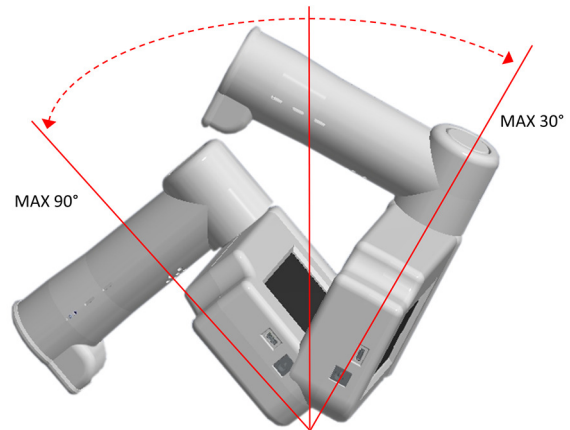

FIGURE 9 – Welcome



FIGURE 10 – User registration

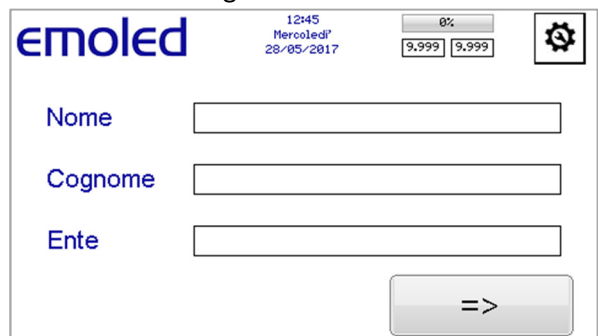
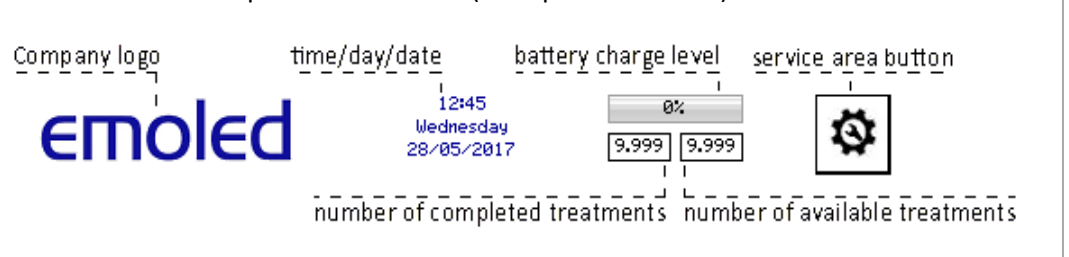

FIGURE 11 – Blow-up of the status bar (on top of the screen)



access to the following functions:

- RESTRICTED AREA (for authorized personnel only)
- DATE/TIME (to modify)
- COUNTERS
- RECHARGE (treatments)
- ESCI (to go back to “Home”)

#### 4.2.1 Treatments recharge

To recharge treatments it is necessary to have a recharge code that is supplied separately.

Go to the Service Area (Fig.14) pressing the related button in the status bar (Fig.11); then press the “RECHARGE” button in the menu. The recharge screen (Fig.13) appears: insert the recharge code through the alphanumeric keyboard that appears by touching the writing area. If the procedure has been correctly executed recharge confirmation appears and the display goes back to Service Area screen: counters in the status bar show “0” (left counter and the updated number of treatments (right counter).

**NOTE.** Codes are unique and work only in combination with the devices they have been create for.

#### 4.2.2 Counters

Once got to the service area and pressed the counters button appear a series of data that are useful in case of remote assistance:

- User’s registered data.
- Log and use’s counters.

#### 4.3 Therapeutic use of the Device

Turn off the Device pressing the ON/OFF button. Accendere il dispositivo premendo il tasto ON/OFF: the “Home” screen appears (Fig.15) and the Device is ready to be used:

1. Insert approximative dimensions in cm of the rectangle that contains the full surface of the wound (see example in Fig. 4). Proceed by pressing the “OK” button.

2. A new screen will appear (Fig.16) with the number of applications necessary to cover the whole area, the time to conduct the application and the distance from the lesion to maintain. By pressing the “START” button the screen of Fig. 17 will appear. Place the Optical Head at the proper distance using the support of the distance indicator. As soon as the correct position is reached the treatment

FIGURE 12 – Date and time settings

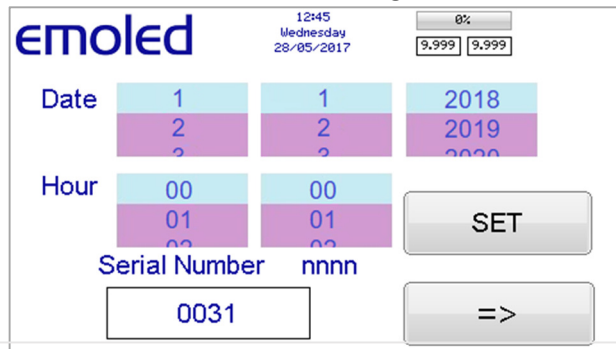

FIGURE 13 – Treatments recharge

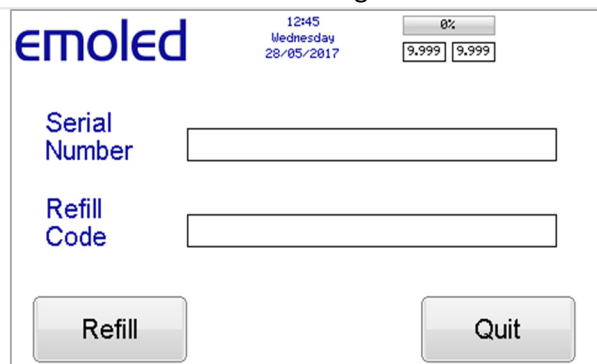

FIGURE 15 – Service Area



FIGURE 15 – Home screen



will start.

**NOTE.** For safety reasons the user has 10 seconds to place the Device at the proper distance after that the Device will resume the pre-start status (Fig. 16) and it will be necessary repeat the whole starting procedure.

**NOTE.** The application area is a circle with 5 cm diameter.

**NOTE.** The correct application distance is 4 cm.

3. During treatment the screen “Assistance to the Application” (see Fig. 17) shows the relevant useful indicators for a correct therapy. For more info on the indicators see after.

4. In case of multiple applications at the end of each, go to the next by pressing the “OK” button below the message of starting next application or just positioning the Optical Head at the right distance: the treatment starts automatically after few seconds. The “Current Application” indicator shows an increase of 1 unit. At the end of the last application on the display appears the “Treatment completed” message.

5. At the end of the treatment the Device goes back to “Home” screen.

Here below are represented in detail the indicators and the information present on display in the “Assistant to application” screen (Fig. 17) during treatment.

#### 4.3.1 Useful indicators for treatment execution

**Distance indicator:** it helps the user to take and keep the correct position of the Optical Head at the beginning and during the treatment (Fig.18).

Pull back: distance between 2 and 3 cm the indicator bar is filling in red from the bottom. You must pull the Head back until the bar turn blue;

Keep: distance 4 cm (+/- 1 cm) the bar fills in blue colour.

Pull forward: distance between 5 and 6 cm the bar is full red, you must move the Head closer until the bar turn blue.

**Treatment progression:** on the display appears the “Total” indicator with the number of application needed to terminate the full treatment and the “Current application” indicator with the progressive number of the current application. (Fig. 17).

FIGURE 16 – Treatment parameters

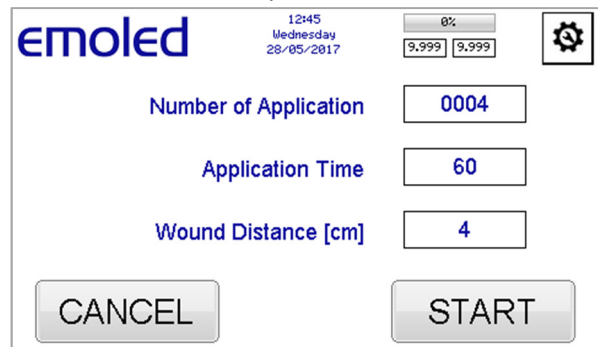

FIGURE 17 – Assistance to the application

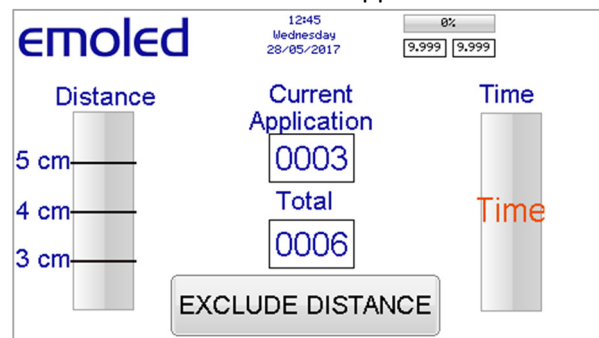

FIGURE 18 – Distance indicator

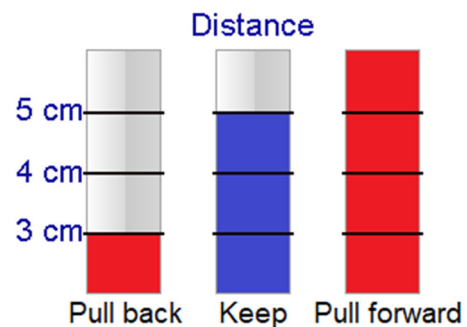

FIGURE 19 – Error message



**Timer:** it is a countdown to the end of the application: the “Time” bar empties itself progressively and the number at the centre provides information on the time left (Fig.17).

#### 4.4 Distance Sensor

The Device is provided with a proximity sensor to help the user to set and keep the Device at the right distance from the wound to guarantee the application of the right dose of light, to prevent errors or to avoid the switching on of the light by mistake. The sensor is located near the emission edge (see Fig. 1) and it is specifically positioned to measure the distance from the centre of the irradiated area. Positioning the wound in the centre of the light circle the distance will be properly measured (Fig.3).

If the Optical Head’s distance from the wound isn’t between the allowed parameters for the treatment (4cm +/-1) the Device stops light emission and a “Distance error” message appears (Fig.19). To resume the treatment: position the Optical Head at the correct distance and wait 3 seconds.

Only if the distance sensor isn’t able to detect the surface to be treated as in the case of fingers or other ends, it is possible to exclude it, pressing the “EXCLUDE DISTANCE” button: the application starts immediately.

**Note.** *During the treatment is not possible to pause the execution of an application for more than 10 seconds; after a 10 second pause the treatment is considered concluded even if the applications aren’t ended and on the display appears the “Home” screen.*

#### 4.5 Operations to be accomplished after Device’s use

After use it is necessary to perform the following operations for a correct storage of the Device:

1. Remove the screen for the visual comfort.
2. While the Device is off and disconnected from the electrical power, clean the enclosure and the optical lens with a gauze soaked in ethylic alcohol as done before use.
3. Set back the Optical Head in the “rest” position (see Fig. 1) following the rotating instructions described in par 3.2.
4. Place Device and accessories in the original case.
5. Keep the Device in a safe and proper place.

To guarantee the correct performance of the product and avoid **residual risks** associated with the Device it is recommended to use it following the Manual instructions.

To plan maintenance interventions and ask information contact EMOLED srl customer service writing an e-mail to: [info@emoled.com](mailto:info@emoled.com) or visit [www.myemoled.com/contacts](http://www.myemoled.com/contacts) to contact the requested office.

**Notice:** The maintenance and the substitution of parts must be executed **only** by technical staff authorized by the manufacturer.

Intervention by non-authorized people and/or the substitution of original components with others cancels the guarantee.

The manufacturer declines any responsibility on adverse events occurred after such intervention.

The Device useful life is 5 years; this time has to be calculated from the year of fabrication shown on the label. Outside this term the manufacturer does not guarantee the maintenance of the performances.

## 5 LABELS

Below are reported position and format of device' and accessories' labelling.

FIGURE 20 – Labels on the Device

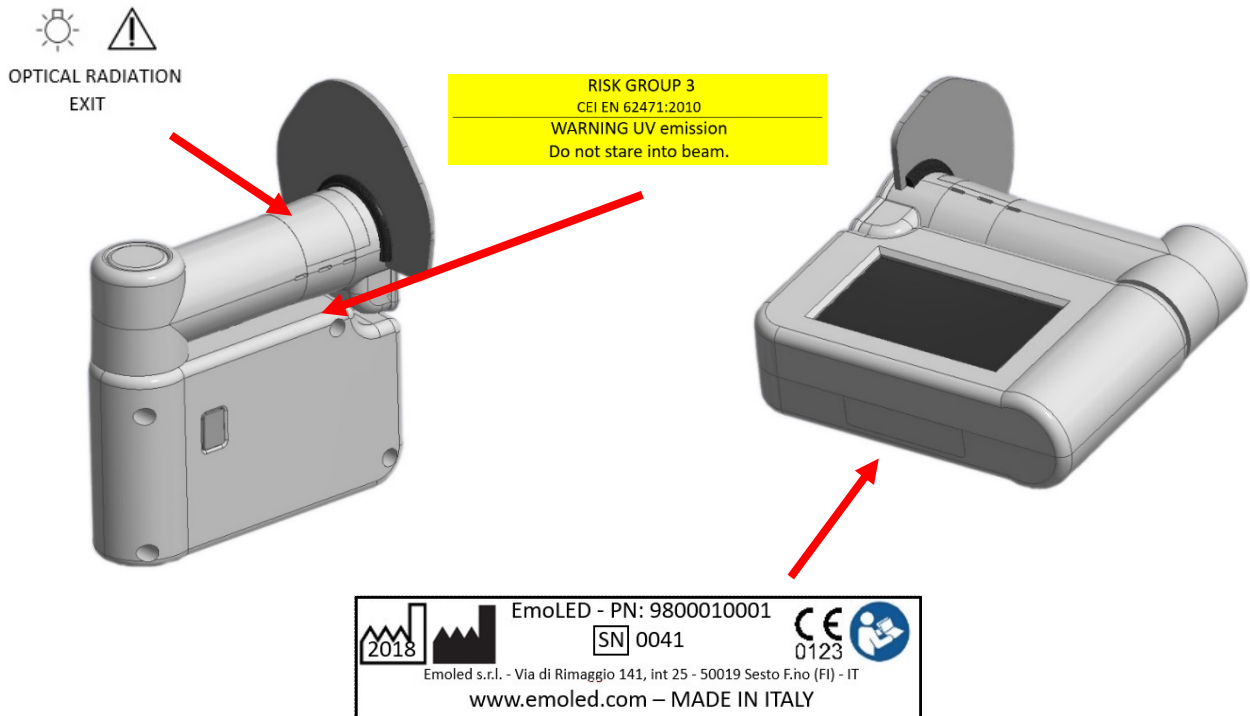
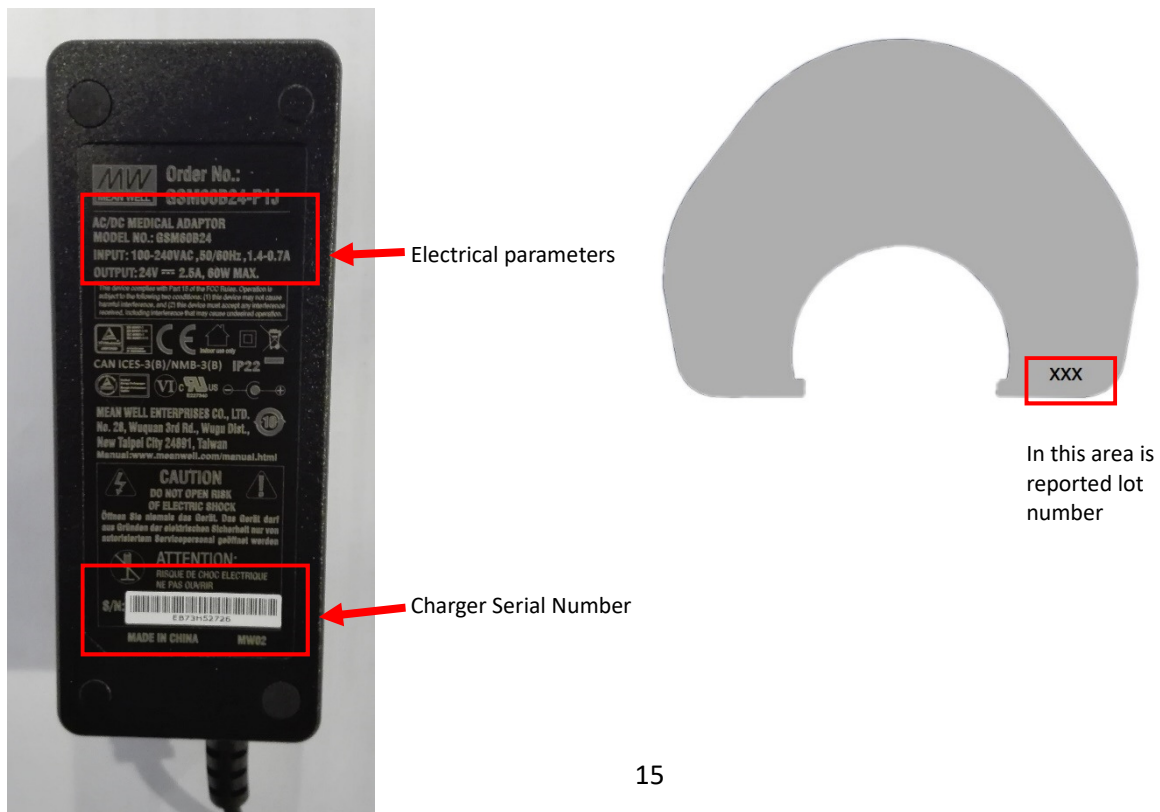

FIGURE 21 - Labels on accessories



## 6 WARNINGS/ERROR MESSAGES/MALFUNCTIONS

The display can show two types of messages:

- Warning Message (text in blue colour): follow instructions.
- Error Message (text in red colour): see list.

Here below the list of potential messages that may appear:

	<b>Text message</b>	<b>Action</b>
Error Message	Wrong distance	Set the correct position or press the "EXCLUDE DISTANCE" button
	Please enter wound's size	Press the "OK" button and enter the requested information
	Institution not valid	Enter the requested information
	Insufficient battery charge	Connect the Device charger to the main power supply to charge batteries before starting treatment

List of possible malfunctions:

	<b>Malfunction type</b>	<b>Message</b>	<b>Action</b>
Malfunction	The Device does not turn on	None	Check the battery charge. Connect the Device to the main power and check the charge level. If the problem remains, contact the assistance.
	The Device does not recharge	None	Check the connection to the main power. If the problem remains, contact the assistance.
	If The Device does not emit light	None	Check to be at the correct distance. If the problem remains, contact the assistance.
	The display does not work	None	Try to reset the Device. If the problem remains, stop to use it and contact the assistance.
	Sensor does not measure distance	Warning message on display	Try to reset the Device. If the problem remains, stop to use it and contact the assistance.
	LED temperature too high	Warning message on display	Turn off the Device and contact the assistance.
	Batteries temperature too high	Warning message on display	Contact the assistance.

**NB:** to contact assistance go to: [www.myemoled.com/contacts](http://www.myemoled.com/contacts).



## **7 DEVICE MANAGEMENT**

### **7.1 Correct use**

For a proper performance of the Device and to avoid adverse events both for the user and the patient it is recommended:

- to read carefully the Manual before using the Device;
- to clean the Device before every use;
- to follow instruction for handling described in chapter 3;
- to use on acute and chronic skin wounds with the exception of neoplastic wounds;
- not to use on patients with porphyria;
- to prevent the use by personnel other than the one expressly indicated in this Manual;
- do not use the Device if it is not intact or if it is damaged;
- to avoid that the Device touch the injured skin of the patient;
- do not sabotage or modify the Device;
- to start the light only after insertion of the accessory screen on the Optical Head;
- do not put the Device or part of it in fluids or liquids;
- do not point the light in the eyes.

### **7.2 Device conservation**

For a correct conservation of the Device and the preservation of its characteristics it is recommended to store the Device in its case in a proper and safe place out of the reach of non-authorized personnel and always together with the present Manual.

### **7.3 Packaging and shipping**

The device has a multilayer packaging.

For shipping it is recommended the use of its original case and its original packaging carrying the proper labels for a safe shipment.

In case of loss of the original package it is recommended to use an adequate packaging for shipment.

The shipment information are available on the web site [www.myemoled.com/contacts](http://www.myemoled.com/contacts) or in this Manual.

### **7.4 Disposal**

End-of-life disposal of the Device must be done according to the Waste Electrical and Electronic Equipmen (WEEE) regulations, managed by the manufacturer, using a recycling collective system of electrical and electronic waste.

### **7.5 Cybersecurity**

The device is not provided of any wireless computer communication interface, so it is not possible to communicate with the device from the outside. The Micro-USB port located on the Device is inactive and it is not intended to be used by the user. The possible insertion of a cable in this port doesn't cause any action nor the malfunctioning of the Device.

## 8 TECHNICAL DATASHEET

PRODUCT:	EmoLED v.1
PRODUCT CODE:	980 0010 001
RISK CLASS:	Ila
PHOTOBIOLOGICAL RISK GROUP:	RG III
PRODUCT:	EmoLED is a medical device which aids the healing process of acute and chronic wounds of people older than 16 years. It is portable and it doesn't come into contact with the skin.
LIGHT SOURCE:	The light radiation is generated by 6 LED sources. The emitted radiation is made uniform over the entire area by the optical system of the Device.
SPECTRAL BANDWIDTH:	400-430 nm
POWER DENSITY/IRRADIANCE:	120 mW/cm <sup>2</sup>
IRRADIATED AREA:	20 cm <sup>2</sup>
ENERGY DENSITY/FLUENCE:	7,2 j/cm <sup>2</sup>
TREATMENT DISTANCE:	3-5 cm (distance sensor inside)
POWER OUTPUT:	2,3 W – max emission variation 1%
POWER SUPPLY:	Lithium-ion rechargeable batteries. Battery life: 150 applications.
CHARGER:	AC/DC 24Vdc, 2.5A
PACKAGING:	Are included: - Battery charger with connection cable - UV and Blue light protection glasses - Visual comfort accessory - User manual - EVA bag for protection and transport
CE CERTIFICATION:	Certificate n° G1 18 02 99242 002
CND (CLASSIFICAZIONE NAZIONALE DEI DISPOSITIVI MEDICI):	M040499
RDM (REPERTORIO DISPOSITIVI MEDICI) CODE:	1693661/R
UMDN:	13037
GMDN:	61721
YEAR OF ENTRY INTO THE MARKET:	2018

## 9 ELECTROMAGNETIC COMPATIBILITY

Table 1 - Guidance and manufacturer's declaration – electromagnetic emission		
The <b>EmOLED</b> device is intended for use in the electromagnetic environment specified below. The customer or the end user of the <b>EmOLED</b> device should ensure that it is used in such an environment.		
Emission test	Compliance	Electromagnetic environment - guidance
RF emission – CISPR 11	Group 1	The <b>EmOLED</b> device uses RF energy to accomplish its purpose. Electronic devices in the nearby could be subject to interferences.
RF emission – CISPR 11	Class B	The <b>EmOLED</b> is suitable for use in all establishments including domestic establishments and those directly connected to the public low voltage power supply network that supplies buildings used for domestic purposes.  ATTENTION: THIS DEVICE is intended to be used by professional staff. The device could result in interference or could disturb the nearby equipment. It could be necessary dispose means of protection like reorient the device or to shield the environment.
Harmonic emissions IEC 61000-3-2	Class A	
Voltage fluctuations/flicker emissions IEC 61000-3-3	Conforms	

Table 2 - Guidance and manufacturer's declaration – electromagnetic immunity			
The <b>EMOLED</b> device is intended for use in the electromagnetic environment specified below. The customer or the end user of the <b>EMOLED</b> should ensure that it is used in such an environment			
Immunity test	IEC 60601 Test level	Compliance level	Electromagnetic environment - guidance
Electrostatic discharge (ESD) IEC 61000-4-2	±6 KV contact ±8 KV air	±8 KV 15 KV	Floors should be wood, concrete or ceramic tile. If floors are covered with synthetic material, the relative humidity should be at least 30%.
Transient/sequence of electrical quick pulse IEC 61000-4-4	±2 KV for power supply lines ±1 KV for input/output lines	±2 KV for electrical power	Mains power quality should be that of a typical commercial or hospital environment.
Overvoltage IEC 61000-4-5	±1 KV between feeding lines ±2 KV between phase(i) and hearth	±1 KV  ±2 KV	Mains power quality should be that of a typical commercial or hospital environment

<p>Voltage dips, short interruptions and voltage variations on the power supply input lines</p> <p>IEC 61000-4-11</p>	<p>&lt; 5% <math>U_T</math> (&gt; 95% dip in <math>U_T</math>) For 0.5 cycle</p> <p>&lt; 5% <math>U_T</math> (&gt; 95% dip in <math>U_T</math>) For 0.5 cycle</p> <p>&lt; 40% <math>U_T</math> (&gt; 60% dip in <math>U_T</math>) For 5 cycles</p> <p>&lt; 70% <math>U_T</math> (&gt; 30% dip in <math>U_T</math>) For 25 cycles</p> <p>&lt; 5% <math>U_T</math> (&gt; 25% dip in <math>U_T</math>) For 5 s</p>	<p>&lt; 5% <math>U_T</math> (&gt; 95% dip in <math>U_T</math>) For 0.5 cycle</p> <p>&lt; 5% <math>U_T</math> (&gt; 95% dip in <math>U_T</math>) For 0.5 cycle</p> <p>&lt; 40% <math>U_T</math> (&gt; 60% dip in <math>U_T</math>) For 5 cycles</p> <p>&lt; 70% <math>U_T</math> (&gt; 30% dip in <math>U_T</math>) For 25 cycles</p> <p>&lt; 5% <math>U_T</math> (&gt; 25% dip in <math>U_T</math>) For 5 s</p>	<p>The amount of the network tens should be that of a typical commercial or hospital environment. If the user of the EmoLED device requires continued operation during mains voltage interruptions, it is recommended to power the EmoLED device with an uninterruptible power supply or a battery.</p>
<p>Power frequency (50/60Hz) magnetic field</p> <p>IEC 61000-4-8</p>	<p>3A/m</p>	<p>3A/m</p>	<p>Power frequency magnetic fields should be at levels characteristic of a typical location in a typical commercial or hospital environment.</p>

Table 4- Guidance and manufacturer's declaration – electromagnetic immunity

The equipment <b>EmoLED</b> is intended for use in the electromagnetic environment specified below. The customer or the end user of the <b>EmoLED</b> should assure that it is used in such an environment			
Immunity test	IEC 60601 Test level	Compliance level	Electromagnetic environment - guidance
<p>Conduct RF IEC 61000-4-6</p> <p>Radiated RF IEC 61000-4-3</p>	<p>3 V eff 150 kHz to 80 MHz</p> <p>10 V/m 80 MHz to 2,5 GHz</p>	<p>3 V</p> <p>10 V/m</p>	<p>Portable and mobile RF communication equipment should be used no closer to any part of the <b>EmoLED</b> device, including cables, than the recommended separation distance calculated from the equation applicable to the frequency of the transmitter.</p> <p><b>Recommended separation distance.</b>  <math>d=1,2*\sqrt{P}</math>  <math>d=0,35*\sqrt{P}</math> 80 MHz to 800 MHz  <math>d=0,70*\sqrt{P}</math> 800 MHz to 2,5 GHz</p> <p>Where P is the maximum output power rating of the transmitter in watts (W) according to the transmitter manufacturer and d is the recommended separation distance in metres (m).</p> <p>Field strengths from fixed RF transmitters, as determined by an electromagnetic site survey, should be less than the compliance level in each frequency range.</p> <p>Interference may occur in the vicinity of equipment marked with the following symbol:</p> <div style="text-align: center;">  </div>
<p>Note 1: at 80 MHz and 800 MHz, the higher frequency range applies.</p> <p>Note 2: These guidelines may not apply in all situations. Electromagnetic propagation is affected by absorption and reflection from structures, objects and people.</p>			

Table 6- Recommended separation distances between portable and mobile RF communication equipment and the **EmoLED**

The equipment **EmoLED** is intended for use in the electromagnetic environment in which radiated RF disturbances are controlled. The customer or the user of the **EmoLED** can help prevent electromagnetic interference by maintaining a minimum distance between portable and mobile RF communications equipment (transmitters) and the **EmoLED** as recommended below, according to the maximum power of communications equipment.

Rated maximum output power of transmitter W	Separation distance according to frequency of transmitter (m)		
	150 KHz to 80 MHz $d=1,2*\sqrt{P}$	80 MHz to 800 MHz $d=1,2*\sqrt{P}$	800 MHz to 2,5 GHz $d=2,3*\sqrt{P}$
0,01	0,12	0,12	0,23
0,1	0,38	0,38	0,73
1	1,2	1,2	2,3
10	3,8	3,8	7,3
100	12	12	23

For transmitters rated at maximum output power not listed above, the recommended separation distance  $d$  in meters (m) can be estimated using the equation applicable to the frequency of the transmitter, where  $P$  is the maximum output power rating of the transmitter in watts (W) according to the transmitter manufacturer.

Note 1: at 80 MHz and 800 MHz, the higher frequency range applies.

Note 2: These guidelines may not apply in all situations. Electromagnetic propagation is affected by absorption and reflection from structures, objects and people.

## 10 GLOSSARY

**Acute wounds:** skin lesion that complete the natural healing cycle within 8 weeks.

**Adjuvant:** Medical Device that does not replace another Device or therapy, but that supports it, improving the patient's quality of life and, in the case of EmoLED, leading to faster healing of the treated wounds.

**ATP:** Adenosine Triphosphate, it is a triphosphate ribonucleotide. ATP is the energy exchange coin used by all cells. Its energy is contained in its high-energy phosphate bonds - the substrate of the ATPase enzyme. Breaking of these bonds gives rise to energy release used for all cellular activities.

**Chronic wounds:** skin wounds lasting more than 8 weeks, which have lost the ability to rebuild their anatomical and functional integrity.

**Cytochrome C:** Cytochromes are a particular family of proteins with high capacity to absorb visible light. In particular, Cytochrome C is sensitive to blue light because it contains Protoporphyrin IX.

**Haemoglobin:** protein contained in the blood that binds and carries oxygen. It consists of 4 heme groups (one heme group is made up of Protoporphyrin IX with a central Iron atom) and it is the main absorber of blue light in the skin.

**LED:** Light Emitting Diode. It is an electronic component that, powered by current, emits light.

**Luminous radiation:** light. In the particular case of EmoLED light is generated by LED sources and is placed in the visible spectrum portion, more precisely in the blue part.

**Manufacturer:** a natural or legal person who is responsible for the design, production, packaging or labelling of the electromedical device (EM), the assembly of an EM system, or the adaptation of the EM device or the EM system, whether such operations are carried out by that person or by a third party on behalf of the person.

**Mitochondria:** organelles present in all types of cells that produce ATP.

**Organelles:** structures provided with membranes present within the eukaryotic cells that perform the various functions needed for the cell to survive.

**Photoacceptor:** a particular category of sensitive and light-reactive proteins located in different cell types. The effect of stimulation with light of these proteins may be different depending on the context in which the protein finds itself.

**Photochemical Effect:** a photochemical effect occurs when the interaction of light with matter leads to a chemical reaction or structural modification of target molecules.

**Photothermal Effect:** a photochemical effect occurs when energy absorbed by the tissue is used to produce heat. Depending on the temperature reached by the irradiated zone, it is referred to as hyperthermic (reversible phenomenon,  $T < 50\text{ }^{\circ}\text{C}$ ), coagulative (irreversible phenomenon,  $50\text{ }^{\circ}\text{C} < T < 100\text{ }^{\circ}\text{C}$ ), vaporization (irreversible phenomenon,  $T = 100\text{ }^{\circ}\text{C}$ ) carbonization regime (irreversible phenomenon,  $T > 150\text{ }^{\circ}\text{C}$ ), melting rate (irreversible phenomenon,  $T > 300\text{ }^{\circ}\text{C}$ ).

**Protoporphyrin IX:** Protoporphyrins are cation-transferring molecules (positive ions). In particular, Protoporphyrin IX bounded with an iron ion constitutes the haemoglobin group that carries oxygen to the bloodstream. In other configurations it may be part of complex enzymes, such as Cytochrome C, which is implicated in the respiratory cell leading to ATP production.

**Putting into service:** a procedure that includes the steps and the operations to be taken to use a device. In the case of EmoLED the putting into service consists of the registration operations listed in section 4.1 of this Manual.

**Residual Risks:** risks related to a Medical Device that could not be eliminated with design or mitigated during implementation. They are unavoidable risks related to the use of the device itself or its operating mechanism.

**Wound bed preparation:** literally, preparation of the wound bed. This term refers to all the operations performed by the healthcare staff to prepare the wound bed to be treated in the best possible way, as part of the treatment of skin lesions. These operations include the treatment of necrotic / non-vital tissue, the treatment/control of infection and inflammation, the evaluation of the fluid balance and the control of the epithelial margins.

## 11 GUARANTEE

Guarantee is intended as reparation and/or substitution of components resulting defectives at the origin due to manufacturing reasons. Nevertheless, it is granted the product assistance (for payment) for Devices out of guarantee.

Buyers are entitled to all rights granted by the Italian and European regulation concerning consumer goods, the present guarantee leave such rights unaffected.

To request maintenance interventions or to have technical information regarding the Device, contact an assistance centre or directly the Manufacturer.

The Manufacturer is responsible of the Device conformity to the European Directive 93/42/CEE and its amendment 2007/47/CE for:

- Performances;
- Safety and reliability;
- CE marking.

### Limitations and exclusions

The manufacturer declines any responsibility in case of:

- Installation and put into service not in accord with the prescriptions and precautions listed in the use instruction,
- Use not in accord with the prescriptions and precautions listed in the use instruction;
- Use of accessories and components not supplied or indicated by the Manufacturer;
- Reparations and safety controls executed by technician different from expert personnel, qualified, trained and authorized by the Manufacturer;
- Direct or indirect damages or accidents to people, animals or objects deriving from an improper use of the Device or from incorrect clinical evaluations.

The Manufacturer guarantees the Device for a period of 12 months from the date of invoicing. The guarantee includes substitution, at the Manufacturer site or at an authorized assistance centre, of components and materials including the relative manpower. Shipment and transport costs are not included.

### They are not included in the guarantee:

- Reparation of breakages deriving from natural disasters, mechanical shocks (falls, impacts and so on), defects in the electrical line, negligence, improper use, maintenance and repairs done with non-original components;
- Any other improper use and/or not foreseen by the Manufacturer;
- Damages deriving from lack of performances or inefficiencies caused by circumstances out of the control of the Manufacturer;
- The parts subjected to consumption and degradation by the normal use and the parts resulting damaged by an improper use or by maintenance improperly done by non-authorized personnel.

The client does not have any right to compensation for damages deriving from the stop of the Device.



**Manufacturer communication form**

The user is requested to inform the manufacturer of the occurrence of a critical situation related to the safety risks connected with the use of EmoLED, using the present form.

**NOTE:** please note that the users, that is specialized personnel and/or healthcare professionals both public and private, witnessing during their activity a serious incident involving an EMOLED device have must inform the Minister of Health, in accordance with the terms and conditions laid down in the applicable regulation, and the manufacturer with the following form. All this considering that:

**Incident:** any malfunctioning or deterioration in the characteristics or performance of a device made available on the market, including use-error due to ergonomic features, as well as any inadequacy in the information supplied by the manufacturer and any undesirable side-effect.

**Serious Incident:** any incident that directly or indirectly led, might have led or might lead to any of the following:

- a) the temporary or permanent serious deterioration of a patient's, user's or other person's state of health,
- c) a serious public health threat.

**Serious public health threat:** event that could entail an imminent death risk, a serious deterioration in health conditions of a person or a serious disease that could require an immediate corrective action and could cause a significant human morbidity and mortality rate or that is unusual or unexpected for a given time and place.

The undersigning (name of the organization or of the private user) \_\_\_\_\_

with this document informs EMOLED S.r.l. that the day \_\_\_\_\_ during the use of the Device (serial number) \_\_\_\_\_ in the (write Operative Unit) \_\_\_\_\_

\_\_\_\_\_ of the hospital/ambulatory/Centre of clinical trial (for the centres involved in PMCF investigation with EMOLED devices, for which the Company is the Sponsor, specify *name and number of the Centre*, protocol code and Title of the study )

\_\_\_\_\_ the following event happened (describe the event in detail)\_\_\_\_\_

\_\_\_\_\_

\_\_\_\_\_

\_\_\_\_\_

\_\_\_\_\_

\_\_\_\_\_

\_\_\_\_\_

**12**

For further information please contact: (first and last name)\_\_\_\_\_ role \_\_\_\_\_ telephone \_\_\_\_\_ e-mail \_\_\_\_\_

Place and date

Signature

\_\_\_\_\_

\_\_\_\_\_